

SANYO

INSTRUCTION MANUAL

MDF-U333
MDF-U537
MDF-U537D

BIOMEDICAL FREEZER



MDF-U537/U537D

Note:

- 1. No part of this manual may be reproduced in any form without the expressed written permission of SANYO.**
- 2. The contents of this manual are subject to change without notice.**
- 3. Please contact SANYO if any point in this manual is unclear or if there are any inaccuracies.**

SANYO Electric Biomedical Co., Ltd. All rights reserved. Printed in Japan.

CONTENTS

PRECAUTIONS FOR SAFE OPERATION	P. 2
CAUTIONS FOR USAGE	P. 6
ENVIRONMENTAL CONDITIONS	P. 7
FREEZER COMPONENTS	P. 8
INSTALLATION	P. 11
OPTIONAL COMPONENTS	P. 13
REMOTE ALARM TERMINAL	P. 18
TEMPERATURE SETTING	P. 19
ALARM & SAFETY FUNCTIONS	P. 22
SETTING OF ALARM RESUME TIME	P. 23
ROUTINE MAINTENANCE	P. 24
TROUBLESHOOTING	P. 25
DISPOSAL OF UNIT	P. 25
SPECIFICATIONS	P. 26
PERFORMANCE	P. 27
SAFETY CHECK SHEET	P. 28

PRECAUTIONS FOR SAFE OPERATION

It is imperative that the user complies with this manual as it contains important safety advice.

Items and procedures are described so that you can use this unit correctly and safely. If the precautions advised are followed, this will prevent possible injury to the user and any other person.

Precautions are illustrated in the following way:



WARNING

Failure to observe WARNING signs could result in a hazard to personnel possibly resulting in serious injury or death.

CAUTION

Failure to observe CAUTION signs could result in injury to personnel and damage to the unit and associated property.

Symbol shows;

















-  this symbol means caution.
-  this symbol means an action is prohibited.
-  this symbol means an instruction must be followed.

Be sure to keep this manual in a place accessible to users of this unit.

< Label on the unit >
 This mark is labeled on the cover in which the electrical components of high voltage are enclosed to prevent the electric shock.
The cover should be removed by a qualified engineer or a service personnel only.







PRECAUTIONS FOR SAFE OPERATION

WARNING







-  **Do not use the unit outdoors.** Current leakage or electric shock may result if the unit is exposed to rain water.
-  **Only qualified engineers or service personnel should install the unit.** The installation by unqualified personnel may cause electric shock or fire.
-  **Install the unit on a sturdy floor.** If the floor is not strong enough or the installation site is not adequate, this may result in injury from the unit falling or tipping over.
-  **Never install the unit in a humid place or a place where it is likely to be splashed by water.** Deterioration of the insulation may result which could cause current leakage or electric shock.
-  **Never install the unit in a flammable or volatile location.** This may cause explosion or fire.
-  **Never install the unit where acid or corrosive gases are present** as current leakage or electric shock may result due to corrosion.
-  **Use a dedicated power source** as indicated on the rating label attached to the unit.
-  **Remove dust from the power supply plug** before inserting in a power source. A dusty plug or improper insertion may cause a hazard.
-  **Use a power supply outlet with ground (earth)** to prevent electric shock. If the power supply outlet is not grounded, it will be necessary to install a ground by qualified engineers.
-  **Never ground the unit through a gas pipe, water main, telephone line or lightning rod.** Such grounding may cause electric shock in the case of an incomplete circuit.
-  **Do not insert metal objects such as a pin or a wire into any vent, gap or any outlet** for inner air circulation. This may cause electric shock or injury by accidental contact with moving parts.
-  **Never store volatile or flammable substances** in this unit. This may cause explosion or fire.
-  **Never store corrosive substances** in this unit. This may lead to damage to the inner components or electric parts.
-  **Use this unit in safe area when treating the poison, harmful or radiate articles.** Improper use may cause bad effect on your health or environment.
-  **Disconnect the power supply to the unit prior to any repair or maintenance** of the unit in order to prevent electric shock or injury.
-  **Ensure you do not inhale or consume medication or aerosols** from around the unit at the time of maintenance. These may be harmful to your health.

PRECAUTIONS FOR SAFE OPERATION

WARNING









-  **Never splash water directly onto the unit** as this may cause electric shock or short circuit.
-  **Never disassemble, repair, or modify the unit yourself.** Any such work carried out by an unauthorized person may result in fire or injury due to a malfunction.
-  **Disconnect the power supply plug if there is something wrong with the unit.** Continued abnormal operation may cause electric shock or fire.
-  If the unit is to be stored unused in an unsupervised area for an extended period, **ensure that children do not have access and that doors cannot be closed completely.**
-  **The disposal of the unit should be accomplished by appropriate personnel. Remove doors** to prevent accidents such as suffocation.
-  **Prepare a safety check sheet** when you request any repair or maintenance for the safety of service personnel.

CAUTION

-  **Select a level and sturdy floor for installation.** This precaution will prevent the unit from tipping. Improper installation may result in water spillage or injury from the unit tipping over.
-  **Connect the unit to a power source as indicated on the rating label attached to the unit.** Use of any other voltage or frequency other than that on the rating label may cause fire or electric shock.
-  **When removing the plug from the power supply outlet, grip the power supply plug,** not the cord. Pulling the cord may result in electric shock or fire by short circuit.
-  **Never damage or break the power supply plug or cord. Do not use the supply plug if its cord is loose.** This may cause fire or electric shock.
-  **Do not touch any electrical parts** such as the power supply plug or any switches with a wet hand. This may cause electric shock.
-  **Do not put a container with water or heavy articles on the unit.** It may cause injury if the articles fall. Current leakage or electric shock may be resulted from the deterioration of insulation by spilled water.

PRECAUTIONS FOR SAFE OPERATION

CAUTION

-  **Do not climb onto the unit or do not put articles on the unit.** This may cause injury by tipping or damage to the unit.
-  **Put on dry gloves when you take out refrigerated articles from the freezer.** Handling frozen contents or the inside walls with naked hands may cause frostbite.
-  **Do not defrost inside walls using a knife or ice pick.** There are pipelines for cooling behind the walls. **Be careful not to damage the lines** as this could cause a breakdown. Also, **do not make a hole in the wall** for installation of attachments.
-  **Hold the handle when closing the door.** This will reduce the likelihood of a trapped finger.
-  **Disconnect the power supply plug** before moving the unit. Take care not to damage the power cord. A damaged cord may cause electric shock or fire.
-  **Be careful not to tip over the unit** during movement to prevent damage or injury.
-  **Disconnect the power plug** when the unit is not used for long periods.
-  **Do not put the packing plastic bag within reach of children** as suffocation may result
-  **Remove dust and clean the power supply plug periodically.** The operation with a dusty plug may cause fire.

CAUTIONS FOR USAGE

1. Sometimes the alarm may not operate at the time of first start-up. This does not mean malfunction. It is due to the complete discharge of incorporated battery. 2-day continuous operation of the freezer is necessary to charge the battery fully.
2. The digital thermometer of medical freezer is designed to display the temperature of the center part of the freezing compartment. Although the thermometer sometimes displays a temperature a little bit higher than the actual temperature of the center part, it gradually approaches the real temperature.
3. An access port to take out the measuring cable in the case is provided on the back or left side wall of the freezer. Be sure to replace the cap and heat insulator after take out cable or, the inside temperature cannot complete down, and frost may accumulate outside the port surroundings.
4. Do not use brushes, acids, benzine, thinners, powdered soap. Polishing powders, or hot water for cleaning, as they can deteriorate the painted surfaces and parts made of plastic and rubber. Be especially careful not to wipe plastic or rubber parts with volatile solvents such as benzine. Wipe up the neutral detergents with a wet cloth when used.
5. Frost will accumulate on the inside walls of the freezer during use. Then remove the frost with the spatula provided or a similar tool. Do not defrost inside walls using a knife or ice pick. There are pipelines for cooling behind the walls. Be careful not to damage the lines as this could cause a breakdown. Also, do not make a hole in the wall for installation of attachments.
6. The freezing temperature is different at each position inside the case of this freezer. The set temperature represents the temperature at the center of the inside case. The refrigerated articles put on the highest position part, are refrigerated higher than the set temperature, while those put on the lowest part are refrigerated lower.
7. Do not put too many warm articles into a freezer compartment before enough operating. Put items in a few at a time after the freezer compartment temperature has cooled to at least -20°C .
8. In the case of high ambient temperature, the cabinet front may heat up after the freezer starts to operate first. However, this does not denote a malfunction. It is due to heater or hot gas piped around the unit frame to prevent frost and ice sticking around the cabinet.

ENVIRONMENTAL CONDITIONS

This equipment is designed to be safe at least under the following conditions (based on the IEC 1010-1):

1. Indoor use;
2. Altitude up to 2000 m;
3. Ambient temperature 5°C to 40°C
4. Maximum relative humidity 80% for temperature up to 31°C decreasing linearly to 50% relative humidity at 40°C;
5. Mains supply voltage fluctuations not to exceed $\pm 10\%$ of the nominal voltage;
6. Other supply voltage fluctuations as stated by the manufacturer;
7. Transient overvoltages according to Installation Categories (Overvoltage Categories) II; For mains supply the minimum and normal category is II;
8. Pollution degree 2 in accordance with IEC 664.

FREEZER COMPONENTS

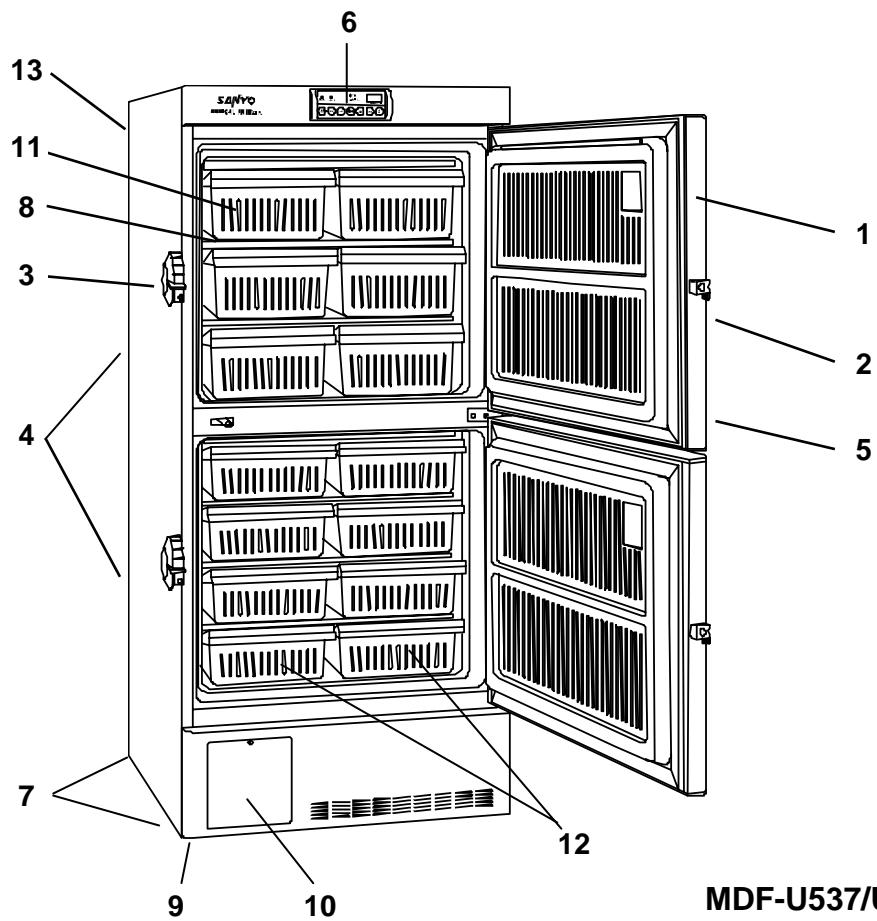
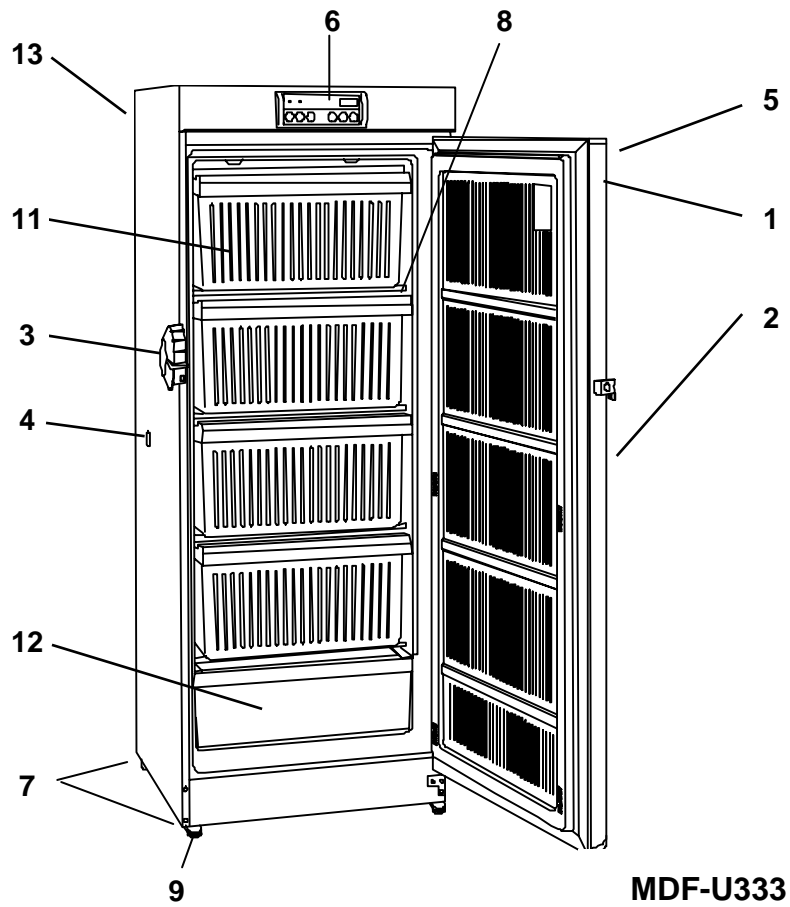

FREEZER COMPONENTS

- 1. Door:** To open the door, grip the handle.
- 2. Handle:** Always grip the handle to open the door.
- 3. Door latch:** To lock the door, turn this latch downward. A padlock is also available.
- 4. Access port:** This is used for leading the measuring cable from the freezing chamber to the outside. MDF-U333 and MDF-U537 has one port and MDF-U537D has two.
- 5. Lock:** By turning to 180 degree to counterclockwise with a key, the door can be locked.
- 6. Control panel:** To display the temperature setting and running condition. See page 10 for details.
- 7. Caster:** 4 casters are provided for easy movement. Separate the front 2 casters from the floor by adjusting the leveling legs at the time of installation.
- 8. Defrost mark:** When this is hidden by frost, defrost the freezer. Refer to page 23 for instructions.
- 9. Leveling foot:** Serves to adjust the height and to settle the frame evenly.
- 10. Space for temperature recorder:** An automatic temperature recorder (optional part) can be attached here. See page 13 "Temperature recorder".
- 11. Storage container:** Made of styrol resin. Be careful not to damage the container by a metal scraper at the time of defrosting.
- 12. Defrost water vessel & storage container:** The container can be used to collect the defrosted water when defrosting.
- 13. Remote alarm terminal:** Used to notify an alarm condition of the unit to remote location. See page 18 for details.
- 14. Battery switch:** Switch for battery used for power failure alarm. Always keep "ON". Turn the switch "OFF" when the unit is in no use for a long period (more than 1 month).
- 15. Power switch:** Switch for the freezer. This switch also activates as an over-current breaker (15 A).

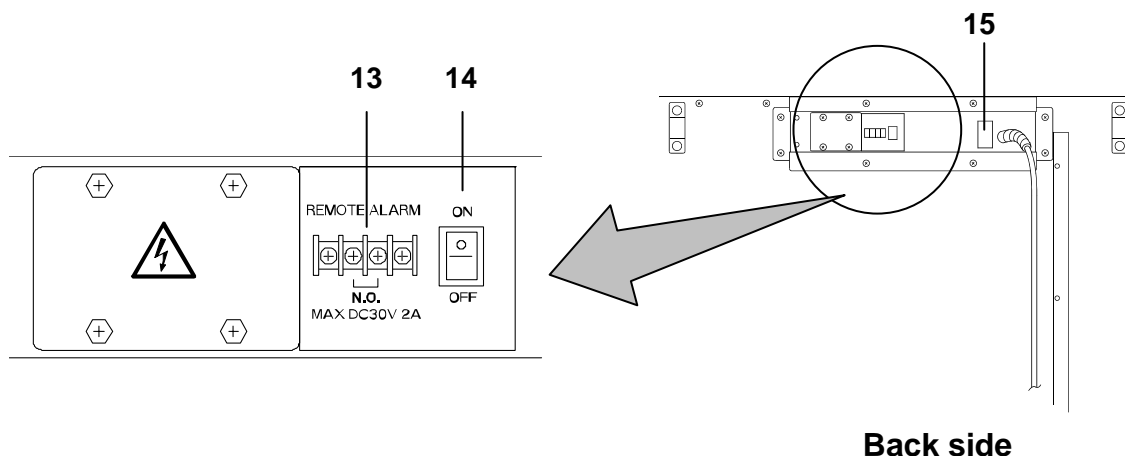

FREEZER COMPONENTS

Control panel and keypad

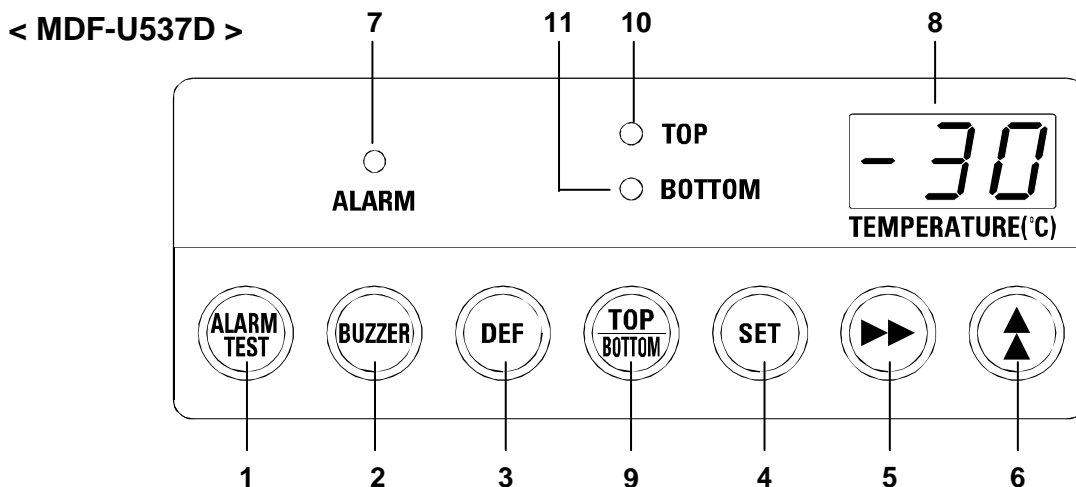

1. Alarm test key (ALARM TEST): Test key for alarm device. By pressing this key, the alarm lamp is flashed, remote alarm is activated and buzzer sound. This means all alarm function operate correctly.

2. Buzzer stop key (BUZZER): To silence the audible alarm, press this key. The remote alarm is also silenced by pressing this key. (The buzzer cannot be stopped during remote alarm testing.)

3. Defrost key (DEF): By pressing this key for 5 seconds, the refrigerating operation is stopped. Pressing this key again after defrosting leads resumption of the operation.

Note: The refrigerating operation never resume automatically after defrosting.

4. Set key (SET): Temperature setting mode is led by pressing this key. Once the key is pressed, the changeable digit is flashed. Pressing this key again after setting desired temperature, the setting is stored into computer memory. If there is no key operation for 90 seconds during the temperature setting mode, the temperature setting mode is invalid automatically. See page 19 for the details.

5. Digit shift key (▶▶): Pressing this key in the setting mode causes the changeable digit to shift. Key lock is available by pressing this key for more than 5 seconds in the temperature display mode. Refer to page 20 for the key lock.

6. Numerical value shift key (▲): Pressing this key in the setting mode causes the numerical value to shift. "ON-OFF" of key lock can be selected by pressing this key in the key lock mode.

7. Alarm lamp (ALARM): This lamp is flashed when the audible alarm is activated.

8. Digital temperature indicator: This indicator shows the present chamber temperature or set temperature.

9. Compartment select key (TOP/BOTTOM) (MDF-U537D only): By pressing this key, internal temperature display of top compartment or bottom compartment and each setting is selected.

10. Top compartment lamp (TOP) (MDF-U537D only): This lamp lights when the top compartment is selected.

11. Bottom compartment lamp (BOTTOM) (MDF-U537D only): This lamp lights when the bottom compartment is selected.

INSTALLATION

Installation site

To operate this unit properly and to obtain maximum performance, install the unit in a location with the following conditions:

1. A location not subjected to direct sunlight

Installation in a location subjected to direct sunlight may lead to inadequate cooling.

2. A location with adequate ventilation

Leave at least 10 cm around the unit for ventilation. Poor ventilation will result in a reduction of the refrigeration capacity.

Avoid direct cool airflow to the heat discharger on the back of the unit by an air-conditioning equipment. The reduction of the refrigeration capacity will be resulted from the unbalance of heat discharge of refrigerating circuit (MDF-U333).

3. A location away from heat generating sources

Avoid installing the unit near heat-emitting appliances such as gas ranges or stoves. Heat can cause inefficient refrigeration.

4. A location with a sturdy and level floor

WARNING

Install the unit on a sturdy floor. If the floor is not strong enough or the installation site is not adequate, this may result in injury from the unit falling or tipping over.

Select a level and sturdy floor for installation. This precaution will prevent the unit from tipping. Improper installation may result in water spillage or injury from the unit tipping over.

5. A location without flammable or corrosive gas

WARNING

Never install the unit in a flammable or volatile location. This may cause explosion or fire.

Never install the unit where acid or corrosive gases are present as current leakage or electric shock may result due to corrosion.

6. A location not prone to high humidity

WARNING

Do not use the unit outdoors. Current leakage or electric shock may result if the unit is exposed to rain water.

Never install the unit in a humid place or a place where it is likely to be splashed by water. Deterioration of the insulation may result which could cause current leakage or electric shock.

INSTALLATION

Installation

1. Remove the packaging materials and tapes

Remove all transportation packaging materials and tapes. Open the doors and ventilate the unit. If the outside panels are dirty, clean them with a neutral detergent and wipe it up with a wet cloth.

2. Adjust the leveling feet

Extend the leveling feet by rotating them counterclockwise to contact them to the floor. Ensure the unit is level.

3. Fix the unit

Two fixtures are attached to the rear of the frame. Fix the frame to the wall with these fixtures and rope or chain.

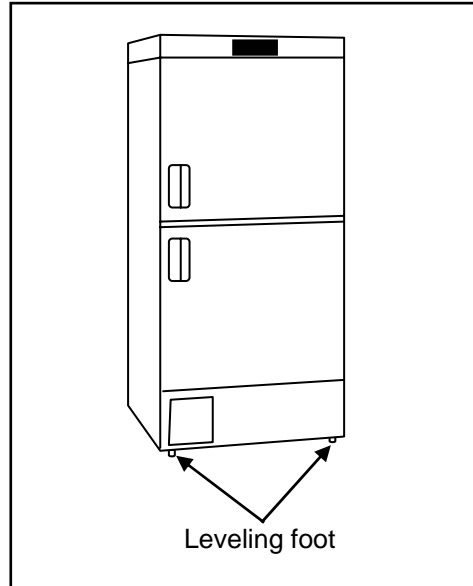

4. Ground (earth)

⚠️ WARNING

Use a power supply outlet with ground (earth) to prevent electric shock. If the power supply outlet is not grounded, it is necessary to install a ground by qualified engineers.

Never ground the unit through a gas pipe, water main, telephone line or lightning rod. Such grounding may cause electric shock in the case of an incomplete circuit.

OPTIONAL COMPONENTS

Temperature recorder

⚠ WARNING

Always disconnect the power supply to the unit prior to attachment of a temperature recorder in order to prevent electric shock or injury.

An automatic temperature recorder is available for the freezer as the optional component. The type of the recorder is MTR-G85. For the attachment, the mounting kit is necessary. Following shows the combination of recorder with the mounting kit:

Temperature recorder	Mounting kit
MTR-G85 (circular chart type)	MPR-S7 (for bottom mounting) MDF-S740T (for top mounting)

In the case of top location

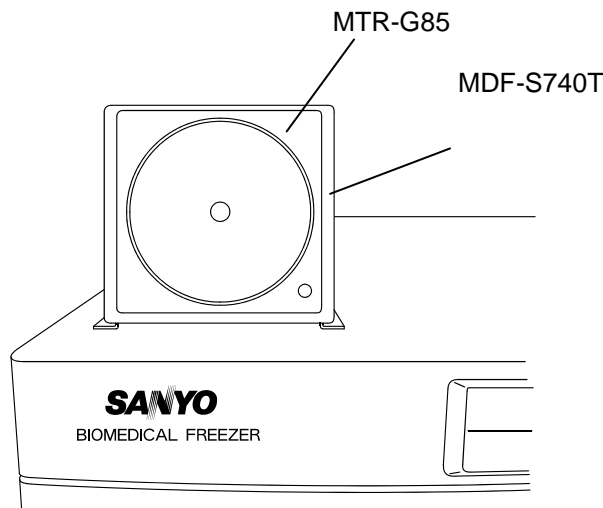

OPTIONAL COMPONENTS

Model MDF-U333: The recorder is located on the top of the freezer.

1. Attach the recorder to the mounting kit by following the procedure shown in the manual enclosed with the mounting kit.
2. Fix the recorder on the top of the freezer by using 4 screws provided with the mounting kit.
3. Remove 2 rubber caps (outside and inside) on the access port on the back of the freezer and also remove the insulation in the port.
4. Pass the recorder sensor into the chamber through the access port. See Fig. 1
5. Push the capillary tube of the recorder into the vertical capillary tube cover on the back of the freezer.
6. After covering the recorder sensor with the cover provided, fix the recorder sensor under the 2nd shelf by using 2 enclosed binders. See Fig. 2.
7. Make a small cut on the rubber caps for capillary to pass.
8. Replace the insulation into the access port and cover the port completely with the rubber caps.
9. Remove the top cover of the freezer by unscrewing 6 screws. Fig. 3
10. Join the wire from the freezer and wire from the recorder by using the enclosed connecting wire. See Fig. 4.
11. Pass the wire through the hole on the top cover and fix the top cover with screws. Make sure the connector is under the top cover
11. Make a small cut on the rubber caps for wire to pass and replace the rubber cap on the top cover.
12. Push in the wire into the recorder mounting kit to accommodate the connector in it.

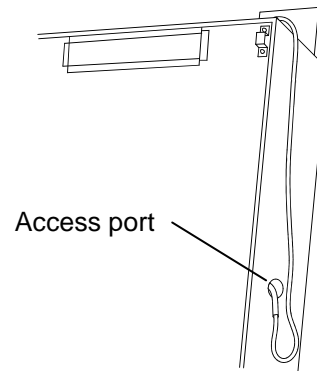

Fig. 1

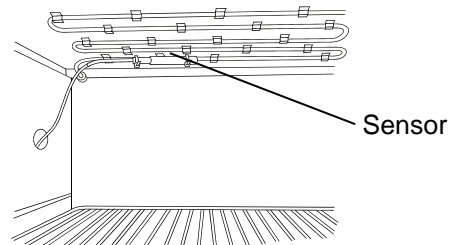

Fig. 2

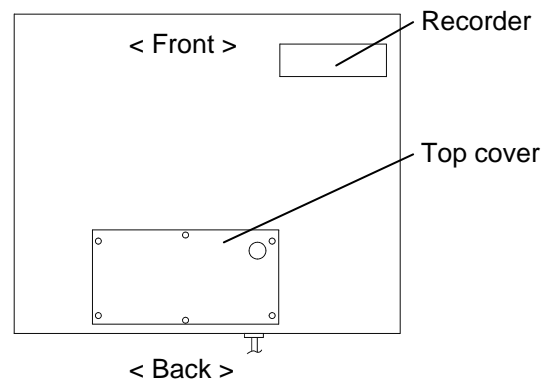

Fig. 3

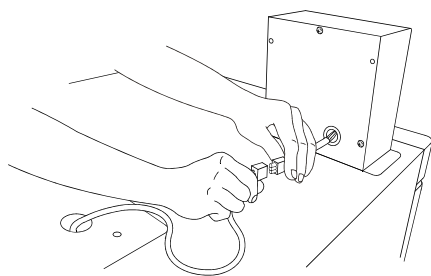

Fig.4

OPTIONAL COMPONENTS

Model MDF-U537: The recorder is located on the left lower front of the freezer.

1. Attach the recorder to the mounting kit by following the procedure shown in the manual enclosed with the mounting kit.
2. Remove the screw on the cover for the recorder space on the lower front of the freezer. Open the cover and push the shaft on the both sides outward to remove the cover. Fig. 5
3. Install the recorder in the recorder space.
4. Join the wire in the unit compartment with the recorder wire by each wire connector. See Fig. 6
5. Remove the wire grille on the back bottom of the freezer. See Fig.7
6. Route the capillary tube of the recorder to the back of the freezer through the unit compartment
7. Remove 2 rubber caps (outside and inside) on the access port on the back of the freezer and also remove the insulation in the port.
8. Pass the recorder sensor into the chamber through the access port. Fig. 8
9. After covering the recorder sensor with the cover provided, fix the recorder sensor under the 3rd shelf by using 2 enclosed binders. See Fig. 9.
10. Make a small cut on the rubber caps for capillary to pass.
11. Replace the insulation into the access port and cover the port completely with the rubber caps.

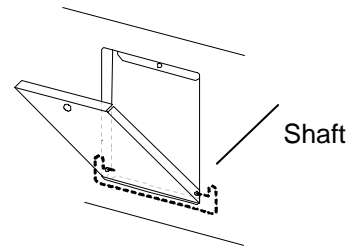

Fig. 5

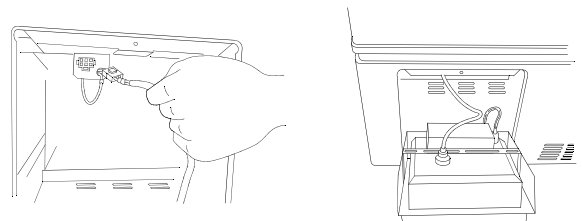

Fig. 6

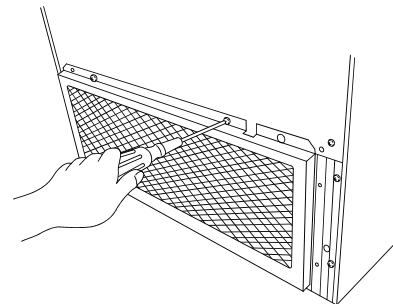

Fig. 7

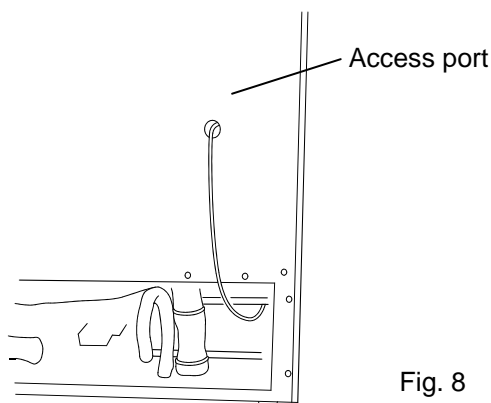

Fig. 8

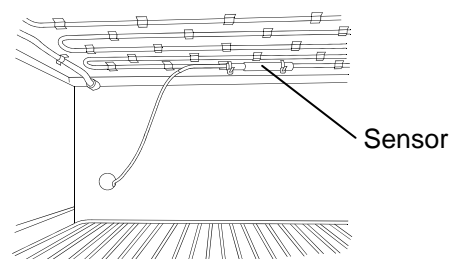

Fig. 9

OPTIONAL COMPONENTS

Model MDF-U537D: The recorder is located on the top of the unit and on the left lower front of the freezer because the upper and lower chamber is controlled independently.

< Attachment of MTR-G85 on the top of the freezer >

1. Attach the recorder to the mounting kit by following the procedure shown in the manual enclosed with the mounting kit.
2. Fix the recorder on the top of the freezer by using 4 screws provided with the mounting kit.
3. Remove 2 rubber caps (outside and inside) on the access port on the back of the freezer and also remove the insulation in the port.
4. Pass the recorder sensor into the chamber through the access port. See Fig. 10
5. After covering the recorder sensor with the cover provided, fix the recorder sensor under the 2nd shelf by using 2 enclosed binders. See Fig. 11.
6. Make a small cut on the rubber caps for capillary to pass.
7. Replace the insulation into the access port and cover the port completely with the rubber caps.
8. Remove the top cover of the freezer by unscrewing 6 screws. Fig. 12
9. Join the wire from the freezer and wire from the recorder by using the enclosed connecting wire. See Fig. 13.
10. Pass the wire through the hole on the top cover and fix the top cover with screws. Make sure the connector is under the top cover
11. Make a small cut on the rubber caps for wire to pass and replace the rubber cap on the top cover.
12. Push in the wire into the recorder mounting kit to accommodate the connector in it.

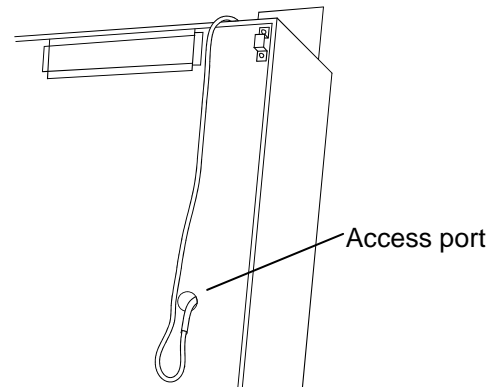

Fig. 10

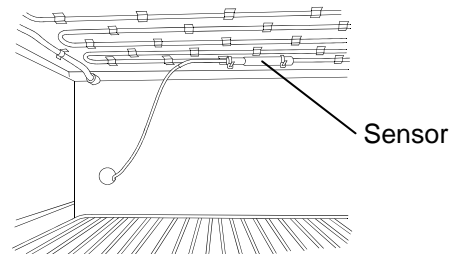

Fig. 11

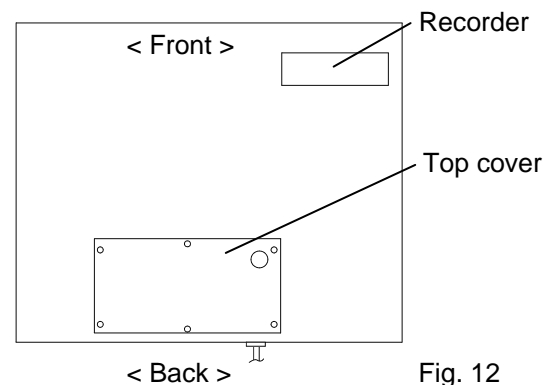

Fig. 12

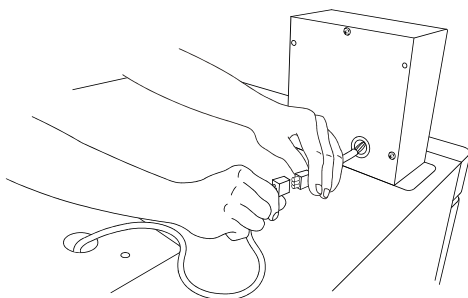

Fig. 13

OPTIONAL COMPONENTS

Model MDF-U537D:

< Attachment of MTR-G85 on the left lower front of the freezer >

1. Attach the recorder to the mounting kit by following the procedure shown in the manual enclosed with the mounting kit.

2. Remove the screw on the cover for the recorder space on the lower front of the freezer. Open the cover and push the shaft on the both sides outward to remove the cover. Fig. 14

3. Install the recorder in the recorder space.

4. Join the wire in the unit compartment with the recorder wire by each wire connector. See Fig. 15

4. Remove the wire grille on the back bottom of the freezer. See Fig. 16

5. Route the capillary tube of the recorder to the back of the freezer through the unit compartment

6. Remove 2 rubber caps (outside and inside) on the access port on the back of the freezer and also remove the insulation in the port.

7. Pass the recorder sensor into the chamber through the access port. Fig. 17

8. After covering the recorder sensor with the cover provided, fix the recorder sensor under the middle shelf by using 2 enclosed binders. See Fig. 18.

9. Make a small cut on the rubber caps for capillary to pass.

10. Replace the insulation into the access port and cover the port completely with the rubber caps.

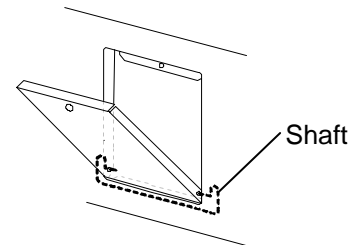

Fig. 14

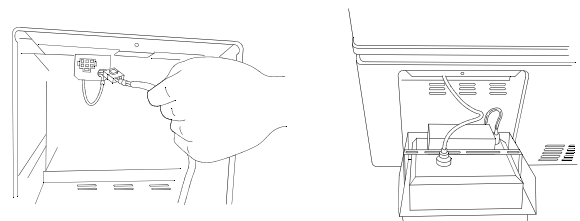

Fig. 15

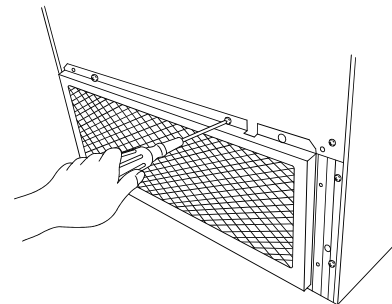

Fig. 16

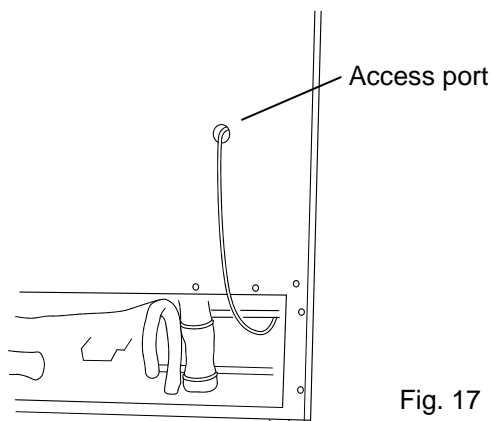

Fig. 17

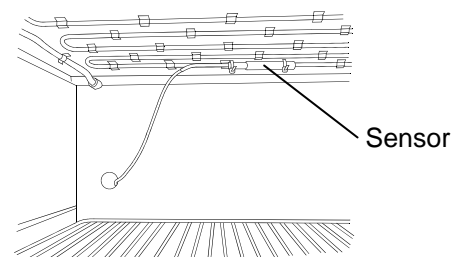

Fig. 18

REMOTE ALARM TERMINAL

WARNING

Always disconnect the power supply cord before connecting an alarm device to the remote alarm terminal.

The terminal of the remote alarm is installed at the back of the unit. The alarm is generated from this terminal. Contact capacity is DC 30V, 2 A.

Contact output: At normal condition "Open"
At abnormal condition "Close"

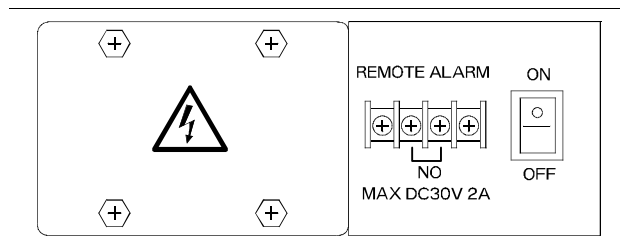

Note:

The remote alarm is silenced by pressing the BUZZER key as the remote alarm is operated in conjunction with the buzzer except for the power failure alarm and alarm test.





TEMPERATURE SETTING

Chamber temperature

Table 1 shows the basic procedure for setting the chamber temperature. Perform key operations in the sequence indicated in the table. The example in the table is based on the assumption that the desired temperature is -25°C.

Note: The unit is set at the factory that the chamber temperature -30°C.

Table 1. Basic operation sequence (Example: Chamber temperature -25°C)

	Description of operation	Key operated	Indication after operation
1	Connect the power plug to exclusive power supply socket.	----	The current chamber temperature is displayed. 
2	(MDF-U537D only) By pressing the compartment select key, select the top compartment.	TOP BOTTOM	Top compartment lamp lights and the current chamber temperature of top compartment is displayed. 
3	Press SET key.	SET	The second digit of the temperature indicator flashes.
4	Set the temperature to 25 with the digit shift key and the numeric value shift key.	▶▶ ▲	By pressing the key, settable digits moves. By pressing the key, the numerical value of the settable digits increases. 
5	Press SET key.	SET	When pressed, the figure of settable digit increases.
6	By pressing the compartment select key, select the bottom compartment. (MDF-U537D only)	TOP BOTTOM	Set temperature is memorized and the current chamber temperature is displayed. 
7	(MDF-U537D only) Perform the same operation as in the case of steps 3 to 5, and set the temperature for the bottom compartment.		The chamber temperature setting is stored, and the current chamber temperature is displayed.

Note:

Although the value of the chamber temperature setting can range from -18°C to -40°C, the guaranteed temperature when there is no load is -30°C when the external temperature is 30°C.

Note that defrosting of this unit is started manually (by pressing the DEF key for about 5 seconds) and stopped manually.

TEMPERATURE SETTING

Key lock function

This unit is provided with the key lock function. When the key lock is ON, change of temperature setting through the key pad is not available. The key lock is set in OFF at the factory.







Display	Mode	Function
	Key lock is OFF	Enable to change of temperature setting
	Key lock is ON	Disable to change of temperature setting

Table 2. Procedure for key lock setting (change from key lock OFF to key lock ON)

	Description of operation	Key operated	Indication after operation
1		----	The current chamber temperature is displayed.
2	Press  key for 5 seconds.		The right digit is flashed.
4	Press  key and scroll the figure to 1.		When pressed, the figure of settable digit increases.
5	Press SET key.	SET	The key lock is set to ON. The current chamber temperature is displayed.

Note:

The key lock only works with the chamber temperature setting and the DEF key. (In the MDF-U537D, the key lock function for both the top and bottom compartments together.)

To release the key lock, select L0 when performing the key lock mode operation described above. (In the MDF-U537D, the key lock can be released in either the top compartment mode or the bottom compartment mode.)

TEMPERATURE SETTING

Alarm temperature setting

This unit is provided with both high and low temperature alarms. The temperature at which the alarm is activated may be changed.

The available set range for high temperature alarm is between +5°C and +15°C, and -5°C and -15°C for low temperature alarm against the chamber temperature.

Note: The temperature alarm is set at $\pm 10^\circ\text{C}$ of the set temperature at the factory.

Display	Mode	Function
F01	High temperature alarm set	See Table 5 on page 22
F02	Low temperature alarm set	See Table 5 on page 22
F03	High temperature alarm set for lower chamber of MDF-U537D	See Table 5 on page 22
F04	Low temperature alarm set for lower chamber of MDF-U537D	See Table 5 on page 22

As an example, Table 3 shows the procedure to set the high temperature alarm so that the alarm can activate when the chamber temperature is 5°C higher than the set temperature.

Table 4 shows the procedure to set the low temperature alarm so that the alarm can activate when the chamber temperature is 5°C lower than the set temperature.

Table 3. Procedure for setting high temperature alarm

	Description of operation	Key operated	Indication after operation
1		----	The current chamber temperature is displayed. -30
2	Press \blacktriangle key for 5 seconds.	\blacktriangle	The first digit is flashed. F00
3	Press \blacktriangle key and scroll the figure to 1.	\blacktriangle	When pressed, the figure of settable digit increases. F01
4	Press SET key.	SET	The right digit is flashed. 010
5	Set the temperature to 005 with the \blacktriangleright key and \blacktriangle key.	\blacktriangleright	Pressing the key shifts the digit which can be set.
		\blacktriangle	When pressed, the figure of settable digit increases. 005
6	Press SET key.	SET	Alarm temperature is memorized and the current chamber temperature is displayed. -30

Table 4. Procedure for setting low temperature alarm

	Description of operation	Key operated	Indication after operation
1		----	The current chamber temperature is displayed. -30
2	Press \blacktriangle key for 5 seconds.	\blacktriangle	The right digit is flashed. F00
3	Press \blacktriangle key and scroll the figure to 2.	\blacktriangle	When pressed, the figure of settable digit increases. F02
4	Press SET key.	SET	The right digit is flashed. -10
5	Set the temperature to -05 with the \blacktriangleright key and \blacktriangle key.	\blacktriangleright	Pressing the key shifts the digit which can be set.
		\blacktriangle	When pressed, the figure of settable digit increases. -05
6	Press SET key.	SET	Alarm temperature is memorized and the current chamber temperature is displayed. -30

ALARMS & SAFETY FUNCTIONS

This unit has the alarms and safety functions shown in Table 5, and also self diagnostic functions.

Table 5 Alarms and safety functions

Alarm & Safety	Situation	Indication	Buzzer	Safety operation
High temperature alarm	If the chamber temperature is higher than the temperature at which the high temperature alarm is activated.	ALARM lamp is flashed. Temperature indicator is flashed.	Intermittent tone with 15 minutes delay.	Remote alarm with 15 minutes delay.
Low temperature alarm	If the chamber temperature is lower than the temperature at which the low temperature alarm is activated.	ALARM lamp is flashed. Temperature indicator is flashed.	Intermittent tone with 15 minutes delay.	Remote alarm with 15 minutes delay.
Power failure alarm	In the case of power failure. When power switch is turned OFF. When the power to the unit is disconnected.	ALARM lamp is flashed.	Intermittent tone	Remote alarm.
Auto-return	When there is no key pressing in each setting mode for 90 seconds.	Chamber temperature is displayed.	-----	Finishing of each setting mode.
Key lock	When the key lock is "ON".	-----	-----	Change of setting is disable.
Thermal sensor Abnormality (for MDF-U537D, upper chamber only)	If the thermal sensor is disconnected.	ALARM lamp is flashed. E01 and chamber temp. are displayed alternately.	Intermittent tone	Remote alarm. Continuous running.
	If the thermal sensor is short-circuited.	ALARM lamp is flashed. E02 and chamber temp. are displayed alternately.	Intermittent tone	Remote alarm. Continuous running.
Thermal sensor abnormality (MDF-U537D, lower chamber only)	If the thermal sensor is disconnected.	ALARM lamp is flashed. E03 and chamber temp. are displayed alternately.	Intermittent tone	Remote alarm. Continuous running.
	If the thermal sensor is short-circuited.	ALARM lamp is flashed. E04 and chamber temp. are displayed alternately.	Intermittent tone	Remote alarm. Continuous running.
Thermal sensor abnormality (MDF-U537, U537D only)	If the protective sensor for compressor is disconnected.	ALARM lamp is flashed. E05 and chamber temp. are displayed alternately.	Intermittent tone	Remote alarm. Normal operation.
	If the protective sensor for compressor is short-circuited.	ALARM lamp is flashed. E06 and chamber temp. are displayed alternately.		
Thermal sensor abnormality (MDF-U537 only)	If the thermal sensor for lower chamber is disconnected.	ALARM lamp is flashed. E07 and chamber temp. are displayed alternately.	Intermittent tone	Remote alarm. Normal operation.
	If the thermal sensor for lower chamber is short-circuited.	ALARM lamp is flashed. E08 and chamber temp. are displayed alternately.		
Battery switch check	When battery switch is OFF at the time of alarm test.	ALARM lamp is flashed. E09 is flashed.	Intermittent tone	Remote alarm.
Compressor temp. Abnormality (MDF-U537, U537D only)	In the case of failure of compressor cooling fan motor. In the case of abnormal high temperature due to the dust on the condenser. In the case of abnormal high ambient temperature.	E10 and chamber temp. are displayed alternately.	Intermittent tone	Remote alarm. Compressor stops running when the temp reaches about 100°C. Electromagnetic valve 1, 2 and compressor stop. (MDF-U537D only)

Note:

1. The above power failure alarm is available when the battery switch is ON and the battery is charged. If the battery switch is OFF or the battery is discharged, only the remote alarm is activated.
2. The power failure alarm can be kept about 12 hours with the battery charged completely. 2-day operation of the freezer is needed to charge the battery full.
3. The chamber temperature is displayed for 5 seconds if the BUZZER key is depressed during the power failure alarm. At the same time, the alarm stops.
4. The remote alarm is silenced by pressing BUZZER key as the remote alarm is operated in conjunction with the buzzer, except for the power failure alarm.
5. After power failure, the operation is resumed with the condition before power failure since the temperature setting and alarm temperature setting are memorized in a nonvolatile memory.







SETTING OF ALARM RESUME TIME

The alarm buzzer and remote alarm are silenced by pressing BUZZER key on the control panel during alarm condition. The buzzer and remote alarm will be activated again after certain suspension if the alarm condition is continued. The suspension time can be set by following the procedure shown in the Table 6 below.

The example in the table is based on the assumption that the desired duration is 20 minutes.

Note: The duration is set in 30 minutes at the factory.

Table 6. Setting procedure for alarm resuming time (change from 30 minutes to 20 minutes)

	Description of operation	Key operated	Indication after operation
1		----	The current chamber temperature is displayed. 
2	Press ▲ key for 5 seconds.	▲	The first digit is flashed. 
3	Set the figure to F25 with the ►► key and ▲ key.	►►	Pressing the key shifts the digit which can be set.
		▲	When pressed, the figure of settable digit increases. 
4	Press SET key.	SET	The current reset time is displayed. The middle digit is flashed. 
5	Set the figure to 020 with the ▲ key.	▲	When pressed, the figure of settable digit increases. 
6	Press SET key.	SET	Alarm temperature is memorized and the current chamber temperature is displayed. 

- The settable alarm resume time are 10, 20, 30, 40, 50, or 60 minutes. The buzzer and remote alarm would not reset if the reset time is set in 000.
- The setting of alarm reset time cannot be changed during the defrosting.
- The buzzer and remote alarm during power failure or alarm testing cannot be silenced.
- The set mode returns to the temperature display mode automatically when 90 seconds has passed without any key operation. In this case, any setting before pressing SET key is not memorized.

ROUTINE MAINTENANCE

WARNING

Always disconnect the power supply to the unit prior to any repair or maintenance of the unit in order to prevent electric shock or injury.

Ensure you do not inhale or consume medication or aerosols from around the unit at the time of maintenance. These may be harmful to your health.

CAUTION

Always put on the dry gloves to protect the hands at the time of maintenance. No gloves may cause cut of the finger by the edge or corner.

Cleaning of cabinet

1. Clean the unit once a month. Regular cleaning keeps the unit looking new.
2. Use a dry cloth to wipe off small amounts of dirt on the outside and inside of the unit and all accessories. If the unit is very dirty, use a neutral detergent.
3. After cleaning, wipe away the cleaner completely with a cloth washed in clean water.
4. Never pour water onto or into the unit. Doing so can damage the electric insulation and cause failure.

- The compressor and other mechanical parts are completely sealed. This unit requires absolutely no lubrication.
- Remove dust from the power supply plug periodically.

Defrosting

Defrost the freezer whenever one of the defrost marks shown by 8 in the figure on page 8 is hidden by frost.

Use the scraper provided for removing the frost if the freezer operation must be continued. Pay attention not to impact or damage the inner wall.

(In the case of MDF-U537D, the top and bottom compartments can be defrosted independently. Perform the following procedure after first using the compartment select key to select the compartment to be defrosted.)

1. When defrosting, temporarily move all the contents of containers in the freezer to another low-temperature freezer.
2. Place the empty defrost/storage container inside the freezer.
3. Press DEF key for 5 seconds to stop the refrigerating operation. While the refrigerating operation is stopped, the current chamber temperature and dF is displayed on the control panel alternately.
4. After a several hours, check visually that all defrost was removed completely.
5. Throw out the water that has accumulated in the defrost/storage containers, then wipe the inside of the freezer dry.
6. Press DEF key so that the refrigerating operation can be started.
7. Once the chamber temperature has dropped to the desired temperature, place the original contents back in the freezer chamber.

Note:

After the defrosting, the refrigerating operation is never resumed automatically. Make sure to press DEF key to start the freezer operation after defrosting.

TROUBLE SHOOTING

If the unit malfunctions, check out the following before calling for service.

The chamber is not cooled at all

1. The circuit breaker of power source is active.
2. The voltage is too low? (In this case, call an electrician.)
3. The power switch is not ON.
4. The large amount of articles (load) is stored in the chamber at one time.
5. The freezer is in defrost condition.

The cooling is poor

1. The ambient temperature is too high.
2. The door is not closed firmly.
3. The large amount of frost is built on the chamber wall.
4. The air intake vent is blocked.
5. The set temperature is not inputted properly.
6. The freezer is in the direct sunlight.
7. There is any heating source near the freezer.
8. A rubber cap and insulation for the access port are not set correctly.
9. You put too many unfrozen articles into the freezer compartment.

When the unit does not accept changes of set-point temperature

1. The key lock is set in "ON" mode.

Noise

1. The freezer is not installed on the sturdy floor.
 2. The freezer is not leveled with the leveling feet.
 3. There is anything touching the frame.
 4. The freezer is in the status immediately after start up.
- The unit sometimes causes a noise when the chamber temperature is high due to the large load. The noise gets less and less accompanying with the cooling of the chamber.

DISPOSAL OF UNIT

WARNING

If the unit is to be stored unused in an unsupervised area for an extended period **ensure that children do not have access and doors cannot be closed completely.**

The disposal of the unit should be accomplished by appropriate personnel. Always remove doors to prevent accidents such as suffocation.



This product has an electric battery.

Please recycle it for effective utilization of resources and protection of our environment.

Thank you for your cooperation.

Label indication is obliged to comply with Taiwanese battery regulation.

SPECIFICATIONS

Name	Biomedical Freezer		
Model	MDF-U333	MDF-U537	MDF-U537D
External dimensions	W614 x D733 x H1620 (mm)	W804 x D772 x H1802 (mm)	W804 x D772 x H1802 (mm)
Internal dimensions	W490 x D485 x H1290 (mm)	W658 x D607 x H1272 (mm)	W658 x D607 x H589 (mm) Upper chamber W658 x D607 x H603 (mm) Lower chamber
Effective capacity	274 L	482 L	452 L
Exterior	Painted steel		
Interior	Styrol resin		
Insulation	Rigid polyurethane foamed-in place		
Outer door	Painted steel		
Lock	1		
Caster	4		
Leveling leg	2		
Evaporator	Tube on sheet type (also used as a shelf)		
Access port	Diameter 30 mm 1 on left side	Diameter 30 mm 1 on back side	Diameter 30 mm 2 on back side
Condenser	Wire and tube type		
Compressor	Hermetic type, 225 W	Hermetic type, 350 W	
Refrigerant	R-134a	R-407D	
Temperature controller	Electronics controller (between -18 and -40°C)		
Temperature display	Digital display (between -50 and +50°C)		
Temperature sensor	Thermistor sensor		
Temperature alarm	Flash of digital indicator and alarm lamp, Buzzer, (Remote alarm)		
Accessories	1 set of key, 1 scraper 4 card holders 4 large baskets W446 x D369 x H220 (mm) 1 small basket W487 x D221 x H155 (mm)	1 set of key, 1 scraper 14 card holders 6 large baskets for upper chamber W290 x D536 x H136 (mm) 8 small baskets for lower chamber W290 x D536 x H100 (mm)	
Weight	81 kg	131 kg	136 kg
Battery	For power failure alarm, Nickel hydrogen battery, DC 6V, 1100mAh, Automatic charge		
Optional component	Automatic temperature recorder (MTR-G85) Mounting kit for automatic temperature recorder (MPR-S7, MDF-S740T)		

Note: Design or specifications will be subject to change without notice.

PERFORMANCE

MDF-U333

Cooling performance	-30°C (ambient temperature; 35°C, no load)			
Temperature control range	-20°C to -30°C			
Rated voltage	AC 110 V	AC 115 V	AC 220 V	AC 220 to 240 V
Rated frequency	60 Hz	60 Hz	60 Hz	50 Hz
Rated power consumption	150 W	140 W	140 W	155 W
Noise level	37 dB [A] (background noise; 20 dB)			
Maximum pressure	1380 kPa			

MDF-U537

Cooling performance	-30°C (ambient temperature; 35°C, no load)			
Temperature control range	-20°C to -30°C			
Rated voltage	AC 110 V	AC 115 V	AC 220 V	AC 220 to 240 V
Rated frequency	60 Hz	60 Hz	60 Hz	50 Hz
Rated power consumption	220 W	230 W	190 W	205 W
Noise level	42 dB [A] (background noise; 20 dB)			
Maximum pressure	1850 kPa			

MDF-U537D

Cooling performance	-30°C (ambient temperature; 35°C, no load)			
Temperature control range	-20°C to -30°C			
Rated voltage	AC 110 V	AC 115 V	AC 220 V	AC 220 to 240 V
Rated frequency	60 Hz	60 Hz	60 Hz	50 Hz
Rated power consumption	250 W	260 W	205 W	225 W
Noise level	42 dB [A] (background noise; 20 dB)			
Maximum pressure	2250 kPa			

Note : The unit with CE mark complies with EC directives 89/336/EEC, 93/68/EEC and 73/23/EEC.

⚠ CAUTION

**Please fill in this form before servicing.
Hand over this form to the service engineer to keep for his and your safety.**

Safety check sheet

- | | | |
|--------------------------------|-----|----|
| 1. Freezer contents : | Yes | No |
| Risk of infection: | Yes | No |
| Risk of toxicity: | Yes | No |
| Risk from radioactive sources: | Yes | No |

(List all potentially hazardous materials that have been stored in this unit.)

Notes :

2. Contamination of the unit

- | | | |
|------------------|-----|----|
| Unit interior | Yes | No |
| No contamination | Yes | No |
| Decontaminated | Yes | No |
| Contaminated | Yes | No |
| Others: | | |

3. Instructions for safe repair/maintenance of the unit

- | | | |
|-------------------------------------|-----|----|
| a) The unit is safe to work on | Yes | No |
| b) There is some danger (see below) | Yes | No |

Procedure to be adhered to in order to reduce safety risk indicated in b) below.

Date :

Signature :

Address, Division :

Telephone :

Product name : Biomedical Freezer	Model : MDF-U333/U537/U537D	Serial number :	Date of Installation :
--------------------------------------	--------------------------------	-----------------	------------------------

Please decontaminate the unit yourself before calling the service engineer.

7FB6P101288007
(5 April 2005)

Recycled paper

SANYO

SANYO Electric Biomedical Co., Ltd.

10-15, Hongo 3-Chome
Bunkyo, Tokyo 113-8434 Japan

Printed in Japan